

DC Contactor SW150 DC Contactor

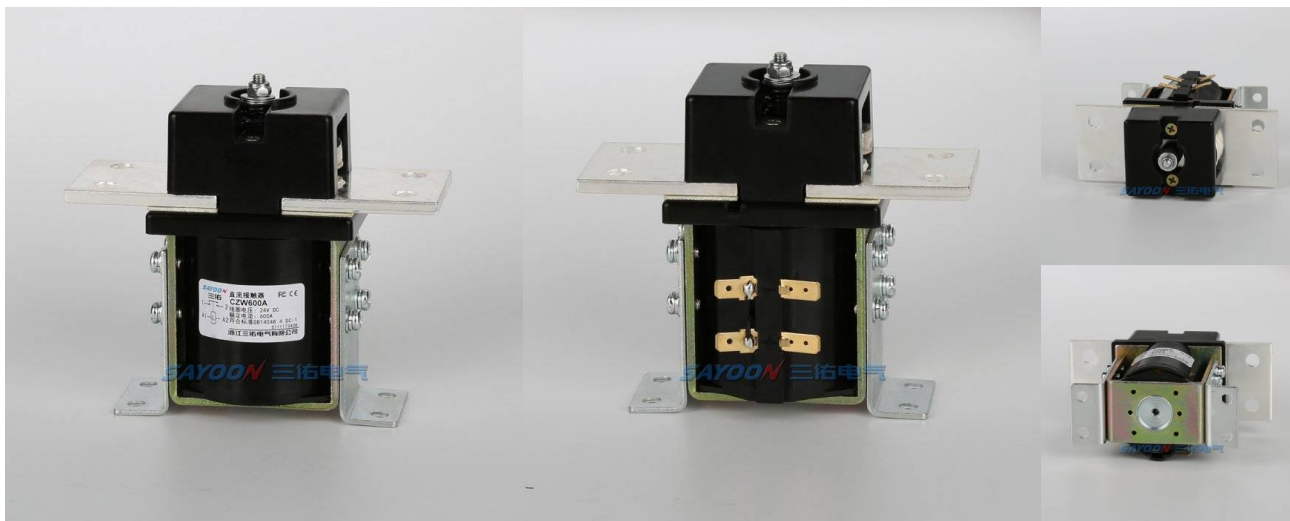

USES

This product have one normally open contact, for electric vehicles, telecommunication equipment, engineering machinery, car batteries, electric forklift trucks, trains, ships, electronic control systems such as uninterruptible power supply.

SW150	-□	-□	/24V
1	2	3	4

- 1 Product type
- 2 Other function codes
- 3 Working system: CO Continuous; INT Intermittent
- 4 Coil rated voltage: 6V,12V,24V,36V,48V,60V,72V,84V,120V,150V,220V etc.

USE OF THE ENVIRONMENT

Contact lead M8 tightening	≥9.0 appropriate
Coil lead-out torque (N.m)	≥0.8 appropriate
Ambient temperature	-25~+70℃
Relative humidity	+20℃ 98%
Vibration freq. at the fixed	3G, 1~50Hz amplitude 0.5mm
Concussion	(60~100) time/minute、
Altitude	2000m
Installation direction	Random
International protection	IP40 (According IEC60947)

ORDER INSTRUCTION

U.N.W.	1406g
Mounting bracket type	2L Two Vertical(default), M Horizontal

ORDER FORM DESCRIPTION

When ordering, please state the following: name, full model, control coil voltage specification, installation frame type, whether with auxiliary contact, order quantity. For example: DC Contactor CZW600A/24V 100pcs, indicating the load rated current 600A, without auxiliary contact, default mounting bracket, coil control voltage 24V purchase 100pcs. Special voltage specification products, such as user needs can be special order.

TECHNICAL PARAMETERS

(Version 1.62)

SAYOON Product Type	SW150
Contact form	1 NO
Coil Rated voltage (DC V)	6V,12V,24V,36V,48V,60V,72V,84V,120V,150V,220V etc.
Contact voltage (DC V)	≤80V
Rated load current of contact 48V circuit (DC-1)	600A
Typical voltage drop across contacts per 100A	≧80mV
The cooling pull-in voltage at (20±5)°C (V)	≧70%
The cooling drop-out voltage at (20±5)°C (V)	≧35%, ≦5%
Working voltage range of 40°C coil	0.8-1.2Us
Drop-out time (n/o contacts to open)	50ms
Pull-in time (n/o contacts to close)	50ms
Maximum bounce time for contact connection	10ms
Maximum bounce time for contact disconnection	3ms
Insulation resistance	20MΩ
Electric strength to resist	50Hz/60Hz 1000VAC 1minute
Typical fault currents which can be ruptured	1800A/5ms at 48V DC
Coil power (W)	20-45
Temperature rise of coil (K)	≤60
Temperature rise on outgoing terminal (K)	≤65
Electrical life	10,000 times
Mechanical life	300,000 times
Work specification	Continuous (default) or Intermittent

LOAD CHARACTERISTIC CURVE

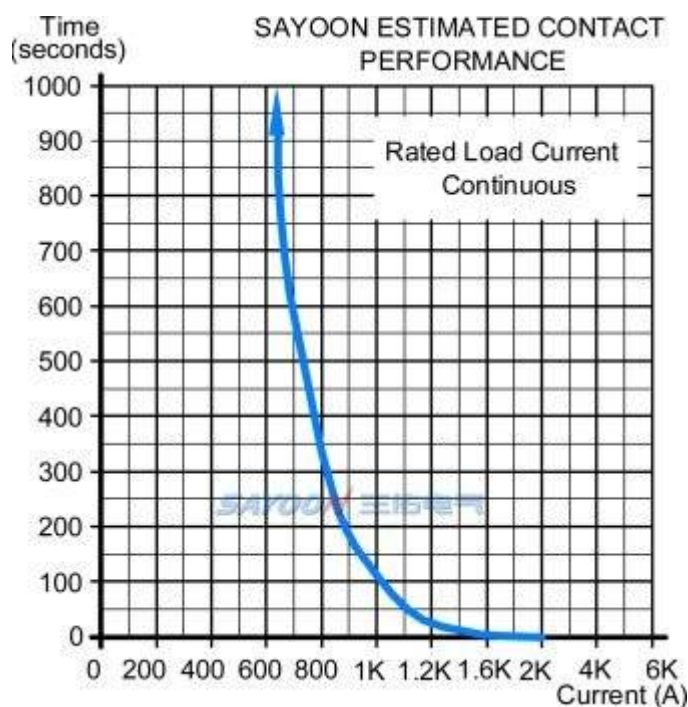
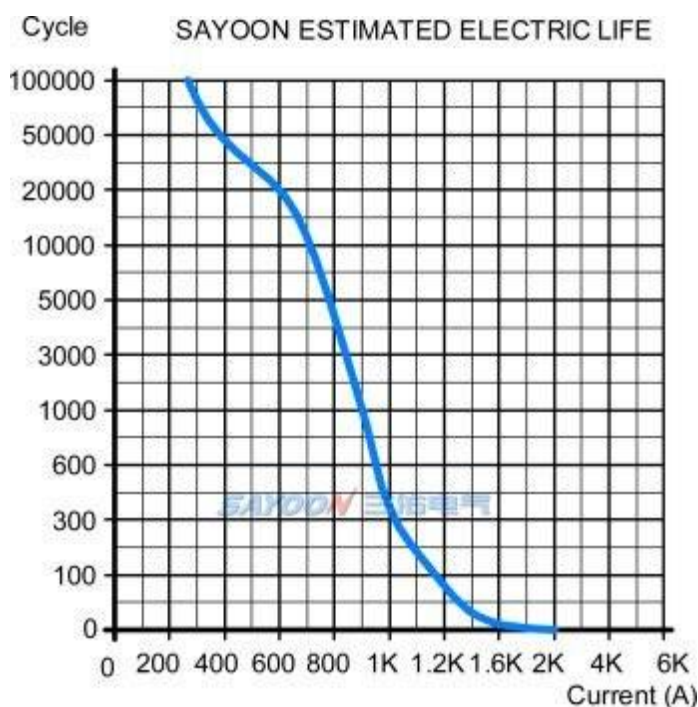

OTHER TECHNICAL PARAMETERS

Contact material	Ag alloy
Load terminal type	2-M8 Screw
Coil terminal type	6.3mm spade terminals
Auxiliary contact rated load (option)	2A/48VDC, 5A/24VDC
Testing organization certification	CE,FCC

Note:As regarding to the different using environments of customers which requires different focus of the functions,and in order to improve the comprehensive properties of our products,sayoon may adjust the coil parameters,temperature rise and so on. The above parameters are for reference only, For details, please refer to the guidelines for selection and use of the SAYOON DC contactor.

INSTALLATION DIAGRAM

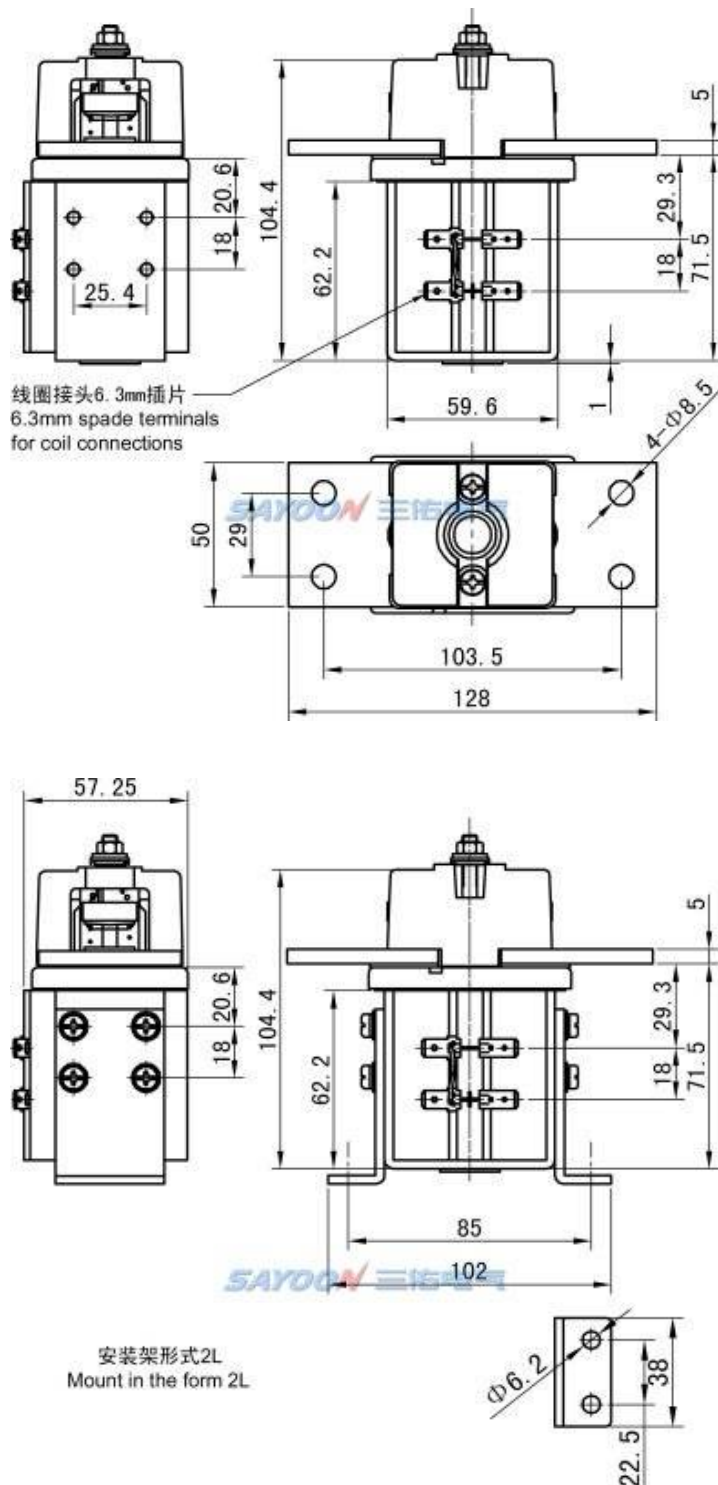

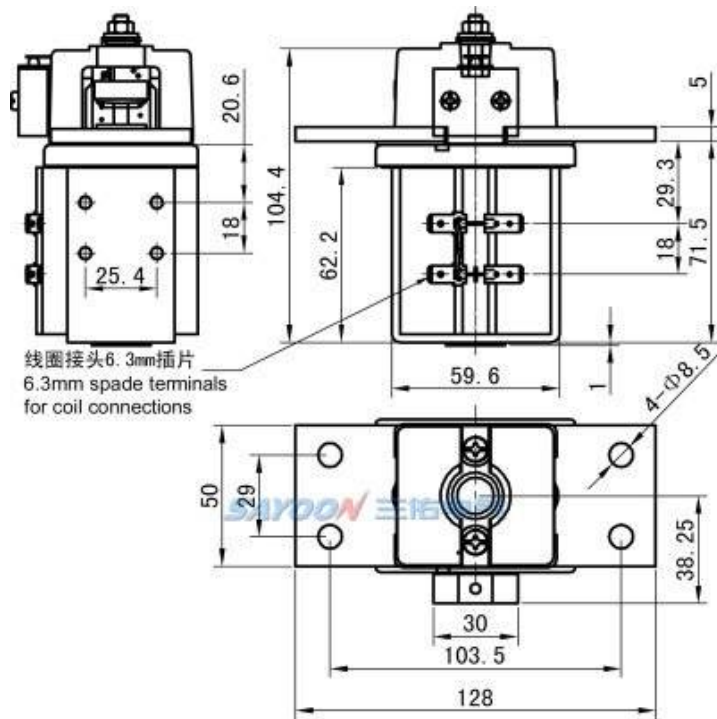
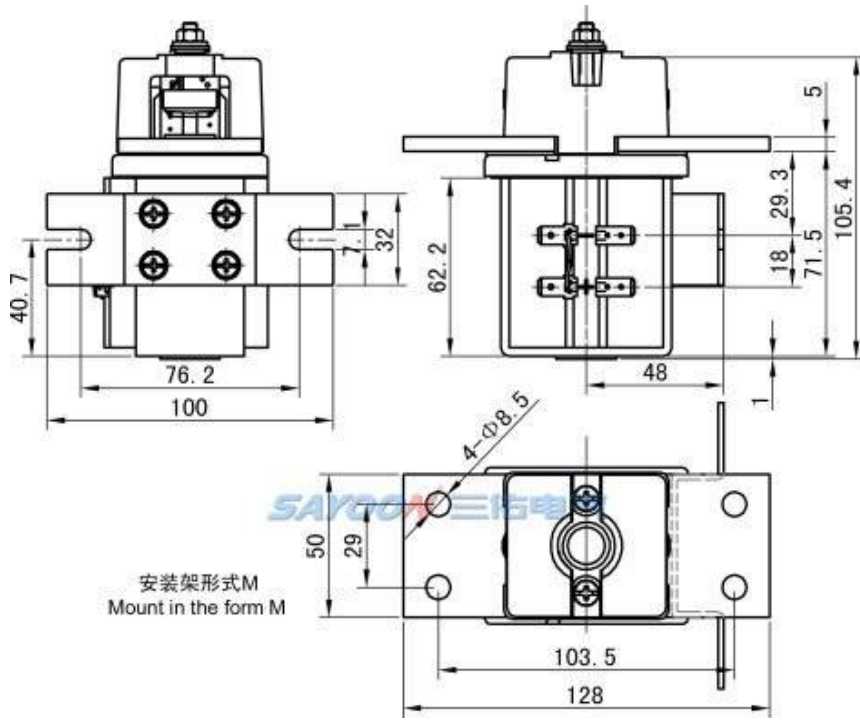

WIRING DIAGRAM

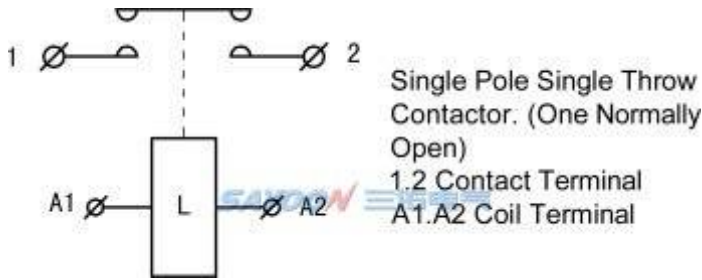

TEMPERATURE RISE CURVE

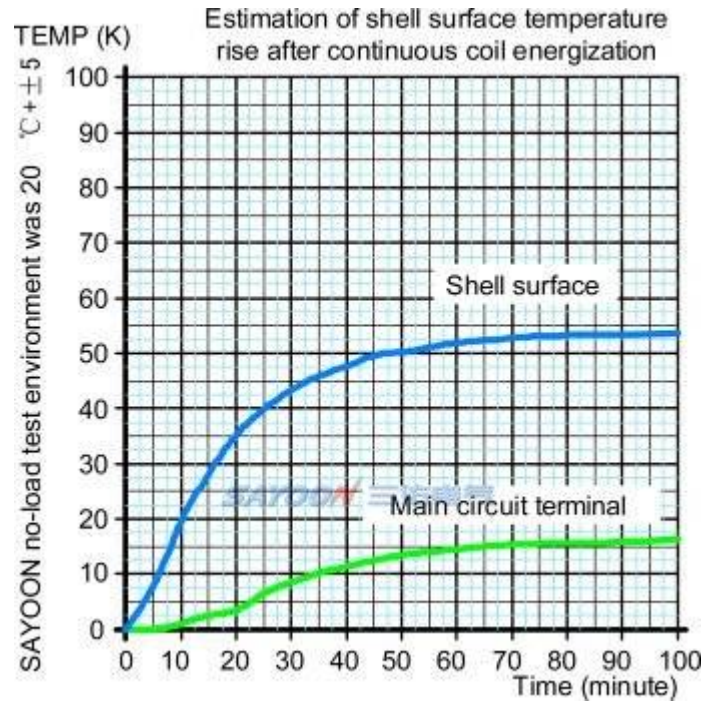

FEATURES

Suitable for electric forklift, battery cars, tractors, excavators, brick machine, cleaning vehicles, automotive air-conditioning, communication power supply, uninterruptible power supply, power supply switches such as electroplating electronic control system control circuit, has the advantages of small volume, large load capacity, long service life, easy maintenance and other characteristics, welcomed by users. The products in accordance with the standard of the JB2286-78, JB3974-85, YD / 585-92, YD / T512-92 requirements; the plant and related test unit test, meet the standard requirements, the user use for many years, the maximum to meet user needs, quality and reliable.